

MODULUS

Cellular Communications Module - 1120R

Modulus Cellular Communications modules wirelessly interconnect and facilitate remote access to Modulus SCADA controllers using 4G LTE communications and the Internet. They support data exchange, (log and report) file transfers, and alarming/notifications by e-mail and text message. These modules also support standard **wired** communications with Modbus, DF1, SDI-12 and Ethernet IP, as well as Ethernet-Serial bridging and Ethernet Routing.

Cellular Communications modules have built-in analog and digital I/O for temperature control, valve monitoring and control, tank level monitoring, and pump control applications such as wells, lift stations and booster pumping stations. They can also serve as communications concentrators with intelligent links to smart monitoring and control devices such as variable frequency drives and power meters.

Modulus Cellular Communications modules have a general purpose serial port that supports multiple types of interfaces; RS-232, RS-485 (2-wire), RS-422 (4-wire), and SDI-12. The buss port may also be used as a general purpose RS-485 serial port if not used for high-speed bus communications with other Modulus I/O modules.

STANDALONE OPERATION

Modulus Cellular Communications modules can serve as standalone devices with SCADA communications, local and web human machine interfaces (HMIs), historical trending and data logging, alarming, reporting, and programmable logic.

COMMUNICATIONS

Modulus Cellular modules have an Ethernet port and a general purpose serial port to communicate with Modbus devices and Allen Bradley PLCs. The module can serve as a communications concentrator or master controller, as well as providing web and data access to any other Modulus modules interconnected via the high-speed bus. Ethernet to Serial bridging, and Ethernet/Cellular routing to other Modulus modules' Ethernet ports, is also supported.

GRAPHICAL, MOBILE, AND LOCAL HMIs

Configurable graphical web and mobile device interfaces are built into the radio modules. The front panel display can also be customized to show live process values and states, and make setting changes.

HISTORICAL TRENDING AND EVENT LOGGING

Modulus Cellular Communications modules have an internal solid state flash disk, as well as a micro SD memory card slot to record over 100 years of data! Use built-in web tools to retrieve and display historical trend and event data and extract it as spreadsheet files.

REPORTING

Reports can be created in minutes showing live values, production totals, trend and event data, alarm summaries, etc. Customize reports with your own logos and graphics. Call up reports on demand, or have them automatically transferred to your computer.



Standard I/O - Verizon
8x-5311 1DI, 1DO, 2AI
Standard I/O - AT&T, T-Mobile & Int'l
8x-5312 1DI, 1DO, 2AI
Extend I/O - Verizon
8x-5811 17DI, 6DO, 4AI, 4AO
Extended I/O - AT&T, T-Mobile & Int'l
8x-5812 17DI, 6DO, 4AI, 4AO

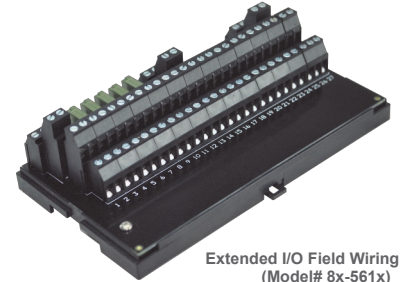

Extended I/O Field Wiring Panel
(Model# 8x-561x)

Modulus Cellular Communications Modules

- 1 ETHERNET PORT
- 1 4G LTE CELLULAR MODEM
- 2 SERIAL PORTS (1 GENERAL PURPOSE AND 1 BUS PORT)
- 1 DISCRETE/HIGH-SPEED PULSE INPUT
- 1 DISCRETE OUTPUT (PROTECTED FET)
- 2 ANALOG INPUTS (OHMS/THERMISTORS)

Extended I/O models(8x-581x) add Field Wiring Panel with:

- 16DI (OPTO), 5 DO (RELAY), 4 AI (20MA), 4AO (20MA)

ALARMING

A Modulus Cellular Communications module can manage alarm conditions on any of its local inputs and other Modulus I/O modules, as well as over 500 conditions monitored by communications with other devices. Alarms conditions can be displayed locally and annunciated by text message and e-mail alerts. Alarms can be acknowledged by text message or e-mail, discrete input, or HMI button. The module maintains a journal spreadsheet file of when alarms occurred, when they were acknowledged, by whom, and when the alarm conditions cleared.

PROGRAMMABLE LOGIC

Modulus Cellular Communications modules support programmable logic written in ladder logic, function block and text languages; all with 32-bit and floating point math. Programmable logic can supplement the built-in functions of the module.

PID & PUMP CONTROL

Modulus Cellular Communications modules have a quad PID controller and a triplex pump controller (float or level control) with error detection and alarming. Without requiring any additional modules, the Cellular Communications Module is an ideal solution for SCADA operation of wells, lift stations, and booster pump stations.

REDUNDANCY

Modulus Cellular Communications modules support redundancy for enhanced reliability. If a module goes off-line, a designated backup can take over automatically.

Modulus Cellular Communications Module - 1120R Specifications

STANDARD FIELD I/O

Digital Inputs:	1	Non-isolated DC or contact closure, DC to 20KHz maximum
Input Range:		Contact closure/open collector driver to ground, or 0 to 30Vdc (ON=<1.5V, OFF > 2.5V), 60Vdc absolute maximum
Input Current:		Approximately 0.5mA (internal current source)
Filtering:		Individually configurable: 5Hz, 10Hz, 20Hz, 50Hz, 100Hz, 500Hz, 1KHz, 2KHz, 5KHz, 10KHz+
Digital Outputs:	1	Solid-state Protected FET high-side driver (switches to input power when ON)
Output Rating:		30Vdc, 2A maximum, current limited to approximately 2.25A.
Analog Inputs:	2	16-bit, Delta Sigma, selectable input ranges
		<ul style="list-style-type: none">• 50K ohms• Thermistor - 2.2K, 10K (type II, III and 11.K shunt)

EXTENDED FIELD I/O (adds to the above with I/O terminations on Field Wiring Panel with 24" cable)

Digital Inputs:	16	Optically Isolated, bipolar (AC/DC, not polarity sensitive)
I/O Range:		0 to 30V (OFF < 6V, ON>9V), 60V absolute maximum
I/O Current:		1.2mA @ 12V, 3mA @ 24V
Filtering:		Individually configurable: 5Hz, 10Hz, 20Hz, 50Hz, 100Hz, 500Hz, 1KHz, 2KHz+
Digital Outputs:	5	Relays, Form A (normally open) Dry Contact- Relays purchased and installed separately as needed (into sockets provided). Relay part# 80-1001
Contact Output Rating:		250 Vac, 30Vdc, 5A maximum per output (resistive load). A snubber diode (DC) or RC snubber (AC) must be used across the relay contacts or load connections for any inductive load.
Analog Inputs:	2	16-bit, Delta Sigma, individually selectable input ranges
Input Range:		<ul style="list-style-type: none">• 20mA (minimum input for full accuracy is 0.5mA)
Maximum signal level:		35Vdc on any range
Analog Outputs	4	12-bit
Output Ranges:		0 to 20mA

COMMUNICATIONS

Ethernet:	1	10/100mb/s (10/100 Base-T)
SCADA Protocols		Modbus TCP & UDP (master/slave), Ethernet IP (master/slave PLC5 & SLC5/05 emulation), Ethernet to Serial bridging
Internet Protocols		HTTP (server), FTP (server & client), ICMP (ping; server & client), NTP (client), DHCP (server & client), DNS, DDNS
Cellular:	1	4G LTE: [8x-5311, 8x-5811] 700(B13)/AWS1700(B4)/1900(B2) (Verizon)
		4G LTE: [8x-5312, 8x-5812] 700(B12/B13)/850(B5)/AWS1700(B4)/1900(B2) (AT&T, T-Mobile, International)
SCADA Protocols		Modbus TCP & UDP (master/slave), Ethernet IP (master/slave)
Internet Protocols		HTTP (server), FTP (server & client), ICMP (ping; server and client), DNS, DDNS
Serial:	1	RS-232, RS-485, RS-422, SDI-12 (for general purpose communications)
	1	RS-485 Bus port (this port is available for general purpose communications if not used for high-speed bus communications with other modules)
Baud Rates (all ports)		115K, 38.4K, 19.2K, 9600, 4800, 2400, 1200 baud.
Protocols		Modbus RTU (master/slave), DF1 (slave), SDI-12 (general purpose port only)

HMIs

Local:	128x32 graphical, wide temperature range yellow OLED and single pushbutton
Graphical:	Web based, graphic library included. Compatible with most browsers, including Internet Explorer, Firefox, Chrome, Safari, Android
Mobile:	Web based, text only, up to 50 registers. Compatible with most browsers, including Internet Explorer, Firefox, Chrome, Safari, Android

PROGRAMMING

Languages:	Ladder Logic, Function Block, Text—built-in web based graphical and text editor and debugger
Capacity:	64KB logic, 2MB source code, 32-bit integer and floating point math

STORAGE

Registers:	504 Numeric registers, 504 Boolean registers
Internal Flash disk:	32MB
Removable disk:	Micro SD Card (up to 256GB, supplied by customer)

CLOCK

Real Time Clock:	Temperature compensated with lithium battery backup power
Stability:	+/- 3ppm from -30°C to 70°C

GENERAL

Input Power:	10Vdc to 30Vdc
Power Consumption	
Not using Ethernet	68mA @ 12Vdc / 40mA @ 24Vdc (Ethernet power saver enabled)
Using Ethernet	108mA @ 12Vdc / 60mA @ 24Vdc
+ current per relay ON	10mA @ 12Vdc / 5mA @ 24Vdc (extended I/O only)
Field Wiring Termination:	[81-531x, 81-581x] screw terminal blocks [82-531x, 82-581x] lever terminal blocks, 3.5mm, 22 to 14GA wires [81-561x, 82-581x] Added I/O on Field Wiring Panel: 2-tier, 5.08mm screw terminal blocks, 22 to 14GA wires
Antenna Connector:	SMA female (female pin center conductor)
Temperature:	-40°C to 70°C (operating), -40°C to 85°C (storage)
Humidity:	<95% RH (non-condensing)
Enclosure:	Polyamide, light gray (RAL 7035)
Mounting:	35mm DIN rail with bus connector block

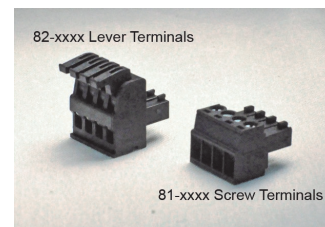

Specifications subject to change without notice. Consult factory to ensure that you are working with current information.

Modulus Cellular Communications Module - 1120R Specifications

DIMENSIONS and WIRING

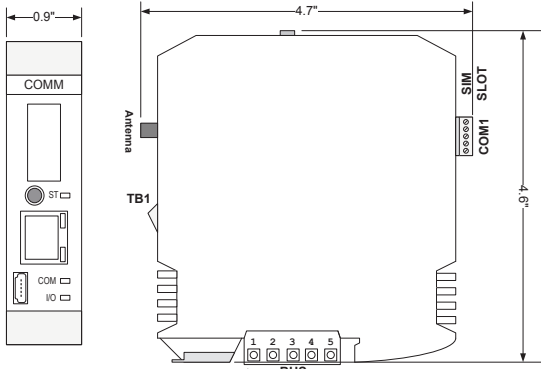

Terminal	Function
1	-485
2	+485
3	RESET#
4	GND
5	+V

TB1 terminals	Inputs/Outputs
1	DI1
2	AI1
3	AI2
4	DO1
5	GND

Refer to the installation manual for additional installation details and precautions.

DISCRETE & ANALOG INPUTS/OUTPUTS—TB1

2 Resistive Sensors

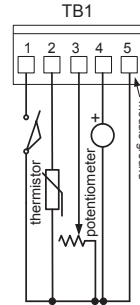

All discrete and analog inputs/outputs are referenced to the ground terminal (5). This terminal is connected internally to the modules power supply ground.

The Discrete Input accepts a contact closure or open-collector ("NPN" style) input signal. An external pull-up resistor is not required.

The Discrete Output sources current ("PNP" style) from the modules input power.

The Analog Inputs support resistive sensors such as potentiometers and thermistor temperature sensors up to 50,000 ohms. 2252 ohm thermistors are generally recommended for the greatest temperature range.

Contact ICL Customer Service for available pre-wired Field Wiring Panel

Extended I/O Wiring (8x-581x) shown on back page

General Purpose Communications Port COM1 (modes are software configured)

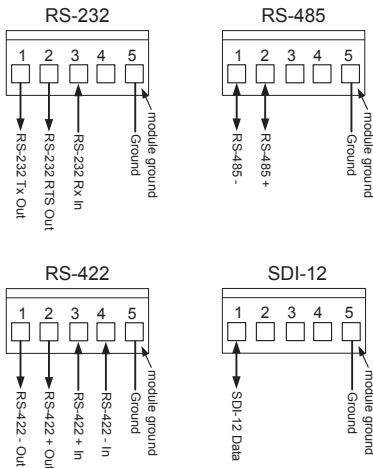

Typical COM1 RS-232 Wiring to Modem/Radio

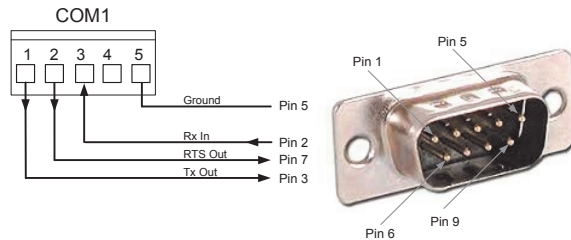

Extended I/O Field Wiring Panel 8x-581x

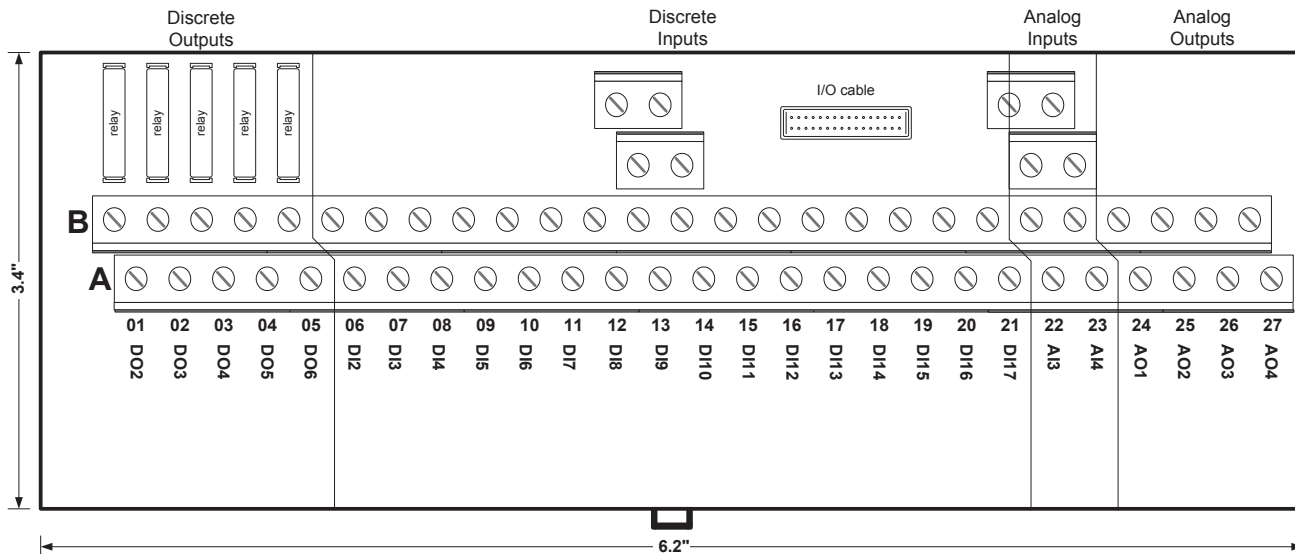

Discrete Outputs Wiring

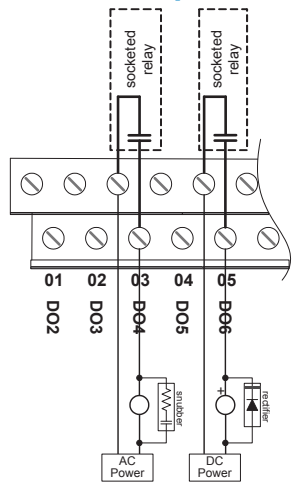

Discrete Inputs Wiring

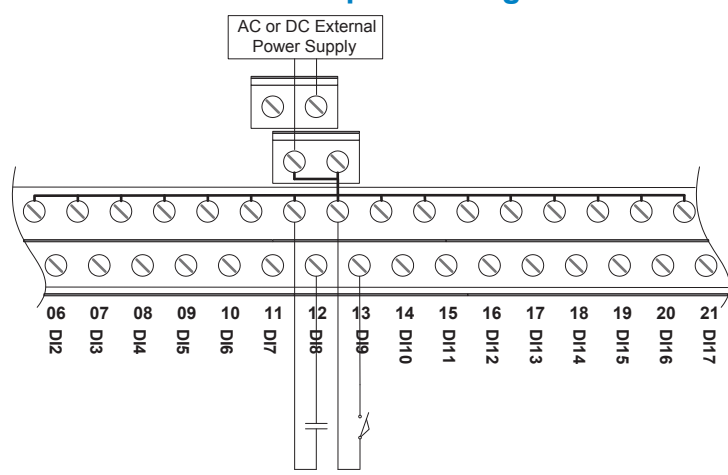

Analog Inputs Wiring Loop Powered Devices

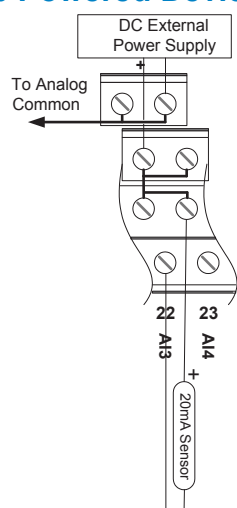

Analog Inputs Wiring Self Powered Devices

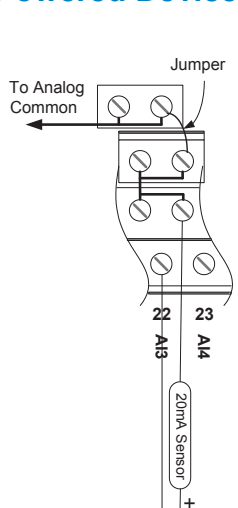

Analog Outputs Wiring

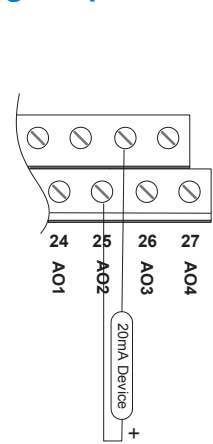

Refer to the installation manual for additional installation details and precautions.