

MODULUS

Meshing Radio Module - 1120R

Modulus Meshing Radio modules link Modulus SCADA controllers, Scadaflex LPR (battery powered) and RIO packaged I/O modules together in a license-free mesh radio network. Meshing enables any node to automatically serve as a repeater, allowing wide-area coverage with less power. Meshing systems are “self healing” so if a node drops out, another will automatically take over message repeater functions. These modules also support standard **wired** communications with Modbus, DF1, SDI-12 and Ethernet IP, as well as Ethernet-Serial bridging and Ethernet Routing.

Meshing Radio modules have built-in analog and digital I/O for temperature control, valve monitoring and control, tank level monitoring, and pump control applications such as wells, lift stations and booster pumping stations. They can also serve as communications concentrators with intelligent links to smart monitoring and control devices such as variable frequency drives and power meters.

Modulus Meshing Radio modules have a general purpose serial port that supports multiple types of interfaces; RS-232, RS-485 (2-wire), RS-422 (4-wire), and SDI-12. The buss port may also be used as a general purpose RS-485 serial port if not used for high-speed bus communications with other Modulus I/O modules.

STANDALONE OPERATION

Modulus Meshing Radio modules can serve as standalone devices with SCADA communications, local and web human machine interfaces (HMI), historical trending and data logging, alarming, reporting, and programmable logic.

COMMUNICATIONS

Meshing Radio modules have an Ethernet port and a general purpose serial port to communicate with Modbus devices and Allen Bradley PLCs. The module can serve as a communications concentrator or master controller. Ethernet to Serial bridging, and Ethernet routing to other Modulus modules' Ethernet ports, is also supported.

GRAPHICAL, MOBILE, AND LOCAL HMIs

Configurable graphical web and mobile device interfaces are built into the Meshing Radio modules. The front panel display can also be customized to show live process values and states, and make setting changes.

HISTORICAL TRENDING AND EVENT LOGGING

Meshing Radio modules have an internal solid state flash disk, as well as a micro SD memory card slot to record over 100 years of data! Use the built-in web tools to retrieve and display historical trend and event data and extract it as spreadsheet files.

REPORTING

Reports can be created in minutes showing live values, production totals, trend and event data, alarm summaries, etc. Customize reports with your own logos and graphics. Call up reports on demand, or have them automatically transferred to your computer.



Standard I/O model
8x-5301 1DI, 1DO, 2AI
Extended I/O model
8x-5801 17DI, 6DO, 4AI, 4AO

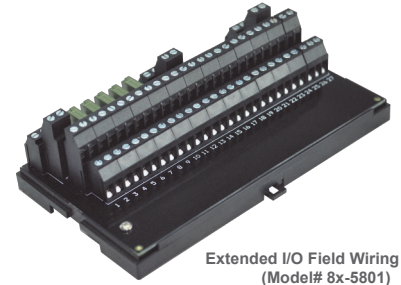

Extended I/O Field Wiring Panel
(Model# 8x-5801)

Modulus Meshing Radio Communications Module

- 1 ETHERNET PORT
- 1 900MHZ LICENSE-FREE MESHING RADIO
- 2 SERIAL PORTS (1 GENERAL PURPOSE AND 1 BUS PORT)
- 1 DISCRETE/HIGH-SPEED PULSE INPUT
- 1 DISCRETE OUTPUT (PROTECTED FET)
- 2 ANALOG INPUTS (OHMS/THERMISTORS)

Extended I/O model 8x-5801 adds Field Wiring Panel with an additional:

- 16DI (OPTO), 5 DO (RELAY), 2 AI (20MA), 4AO (20MA)

ALARMING

A Meshing Radio module can manage alarm conditions on any of its local inputs, as well as over 500 conditions monitored by communications with remote I/O and other devices. Alarms conditions can be displayed locally and annunciated with its discrete output, as well as with a Modulus Cellular Communications module for text message and e-mail alerts. The module maintains a journal spreadsheet file of when alarms occurred, when they were acknowledged, by whom, and when the alarm conditions cleared.

PROGRAMMABLE LOGIC

Meshing Radio modules support programmable logic written in ladder logic, function block and text languages; all with 32-bit and floating point math. Programmable logic can supplement the built-in functions of the module.

PID & PUMP CONTROL

Meshing Radio modules have a quad PID controller and a triplex pump controller (float or level control) with error detection and alarming. Without requiring any additional modules, the Meshing Radio Module is an ideal solution for SCADA operation of wells, lift stations, and booster pump stations.

REDUNDANCY

Meshing Radio modules support redundancy for enhanced reliability. If a module goes off-line, a designated backup can take over automatically.

Modulus Meshing Radio Communications Module - 1120R Specifications

STANDARD FIELD I/O

Digital Inputs:	1	Non-isolated DC or contact closure, DC to 20KHz maximum
Input Range:		Contact closure/open collector driver to ground, or 0 to 30Vdc (ON=<1.5V, OFF > 2.5V), 60Vdc absolute maximum
Input Current:		Approximately 0.5mA (internal current source)
Filtering:		Individually configurable: 5Hz, 10Hz, 20Hz, 50Hz, 100Hz, 500Hz, 1KHz, 2KHz, 5KHz, 10KHz+
Digital Outputs:	1	Solid-state Protected FET high-side driver (switches to input power when ON)
Output Rating:		30Vdc, 2A maximum, current limited to approximately 2.25A.
Analog Inputs:	2	16-bit, Delta Sigma, selectable input ranges
		<ul style="list-style-type: none">• 50K ohms• Thermistor - 2.2K, 10K (type II, III and 11.K shunt)

EXTENDED FIELD I/O (adds to the above with I/O terminations on Field Wiring Panel with 24" cable)

Digital Inputs:	16	Optically Isolated, bipolar (AC/DC, not polarity sensitive)
I/O Range:		0 to 30V (OFF < 6V, ON>9V), 60V absolute maximum
I/O Current:		1.2mA @ 12V, 3mA @ 24V
Filtering:		Individually configurable: 5Hz, 10Hz, 20Hz, 50Hz, 100Hz, 500Hz, 1KHz, 2KHz+
Digital Outputs:	5	Relays, Form A (normally open) Dry Contact- Relays purchased and installed separately as needed (into sockets provided). Relay part# 80-1001
Contact Output Rating:		250 Vac, 30Vdc, 5A maximum per output (resistive load). A snubber diode (DC) or RC snubber (AC) must be used across the relay contacts or load connections for any inductive load.
Analog Inputs:	2	16-bit, Delta Sigma, individually selectable input ranges
Input Range:		<ul style="list-style-type: none">• 20mA (minimum input for full accuracy is 0.5mA)
Maximum signal level:		35Vdc on any range
Analog Outputs	4	12-bit
Output Ranges:		0 to 20mA

COMMUNICATIONS

Ethernet:	1	10/100mb/s (10/100 Base-T)
SCADA Protocols		Modbus TCP & UDP (master/slave), Ethernet IP (master/slave PLC5 & SLC5/05 emulation), Ethernet to Serial bridging
Internet Protocols		HTTP (server), FTP (server & client), ICMP (ping; server & client), NTP (client), DHCP (server & client), DNS, DDNS
Wireless:	1	900MHz 1/4W (24dBm) Frequency Hopping Spread Spectrum meshing radio, -101 dBm sensitivity @ 200kbps, up to 64 remote nodes
Serial:	1	RS-232, RS-485, RS-422, SDI-12 (for general purpose communications)
	1	RS-485 Bus port (this port is available for general purpose communications if not used for high-speed bus communications with other modules)
Baud Rates (all ports)		115K, 38.4K, 19.2K, 9600, 4800, 2400, 1200 baud.
Protocols		Modbus RTU (master/slave), DF1 (slave), SDI-12 (general purpose port only)

HMI

Local:	128x32 graphical, wide temperature range yellow OLED and single pushbutton
Graphical:	Web based, graphic library included. Compatible with most browsers, including Internet Explorer, Firefox, Chrome, Safari, Android
Mobile:	Web based, text only, up to 50 registers. Compatible with most browsers, including Internet Explorer, Firefox, Chrome, Safari, Android

PROGRAMMING

Languages:	Ladder Logic, Function Block, Text—built-in web based graphical and text editor and debugger
Capacity:	64KB logic, 2MB source code, 32-bit integer and floating point math

STORAGE

Registers:	504 Numeric registers, 504 Boolean registers
Internal Flash disk:	32MB
Removable disk:	Micro SD Card (up to 256GB, supplied by customer)

CLOCK

Real Time Clock:	Temperature compensated with lithium battery backup power
Stability	+/- 3ppm from -30°C to 70°C

GENERAL

Input Power:	10Vdc to 30Vdc
Power Consumption	
Not using Ethernet	18mA @ 12Vdc / 13mA @ 24Vdc (Ethernet power saver enabled)
Using Ethernet	78mA @ 12Vdc / 43mA @ 24Vdc
+ current per relay ON	10mA @ 12Vdc / 5mA @ 24Vdc (extended I/O only)
+ radio transmitting	60mA @ 12Vdc 30mA @ 24Vdc in short transmit bursts
Field Wiring Termination:	[81-5301, 81-5801] screw terminal blocks [82-5301, 8-5801] lever terminal blocks, 3.5mm, 22 to 14GA wires [81-5801, 82-5801] Added I/O on Field Wiring Panel: 2-tier, 5.08mm screw terminal blocks, 22 to 14GA wires
Antenna Connector:	RP-SMA female (male pin center conductor)
Temperature:	-40°C to 70°C (operating), -40°C to 85°C (storage)
Humidity:	<95% RH (non-condensing)
Enclosure:	Polyamide, light gray (RAL 7035)
Mounting:	35mm DIN rail with bus connector block

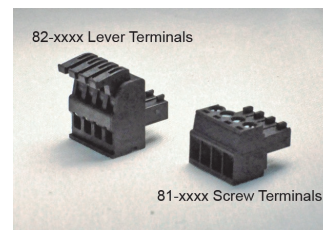

Specifications subject to change without notice. Consult factory to ensure that you are working with current information.

Modulus Meshing Radio Communications Module - 1120R DIMENSIONS and WIRING

DIMENSIONS and WIRING

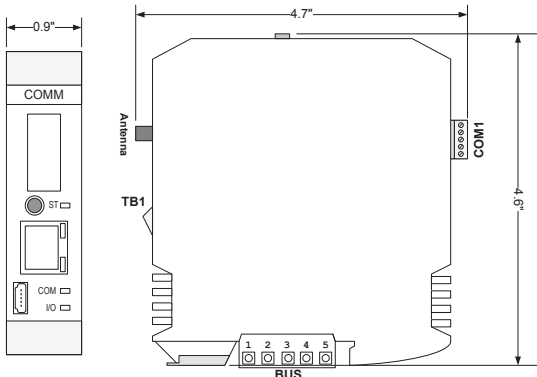

Terminal	Function
1	-485
2	+485
3	RESET#
4	GND
5	+V

TB1 terminals	Inputs/Outputs
1	DI1
2	AI1
3	AI2
4	DO1
5	GND

Refer to the installation manual for additional installation details and precautions.

DISCRETE & ANALOG INPUTS/OUTPUTS—TB1

2 Resistive Sensors

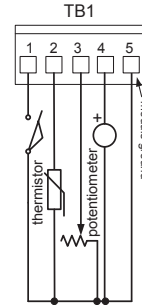

All discrete and analog inputs/outputs are referenced to the ground terminal (5). This terminal is connected internally to the modules power supply ground.

The Discrete Input accepts a contact closure or open-collector ("NPN" style) input signal. An external pull-up resistor is not required.

The Discrete Output sources current ("PNP" style) from the modules input power.

The Analog Inputs support resistive sensors such as potentiometers and thermistor temperature sensors up to 50,000 ohms. 2252 ohm thermistors are generally recommended for the greatest temperature range.

[Contact ICL Customer Service for available pre-wired Field Wiring Panel](#)

[Extended I/O Wiring \(8x-5801\) shown on back page](#)

General Purpose Communications Port COM1 (modes are software configured)

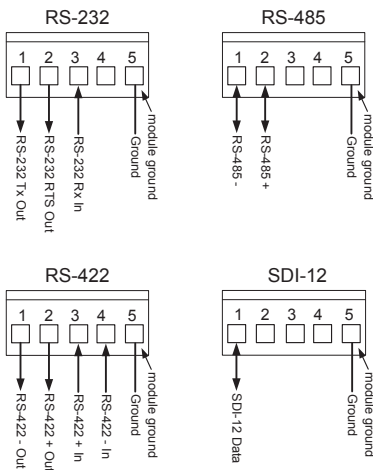

Typical COM1 RS-232 Wiring to Modem/Radio

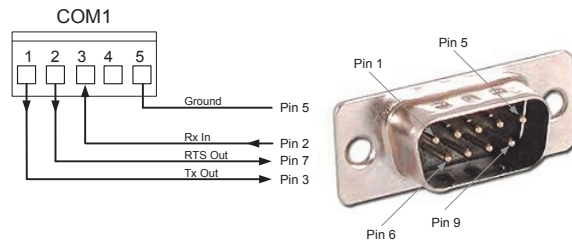

Extended I/O Field Wiring Panel 8x-5801

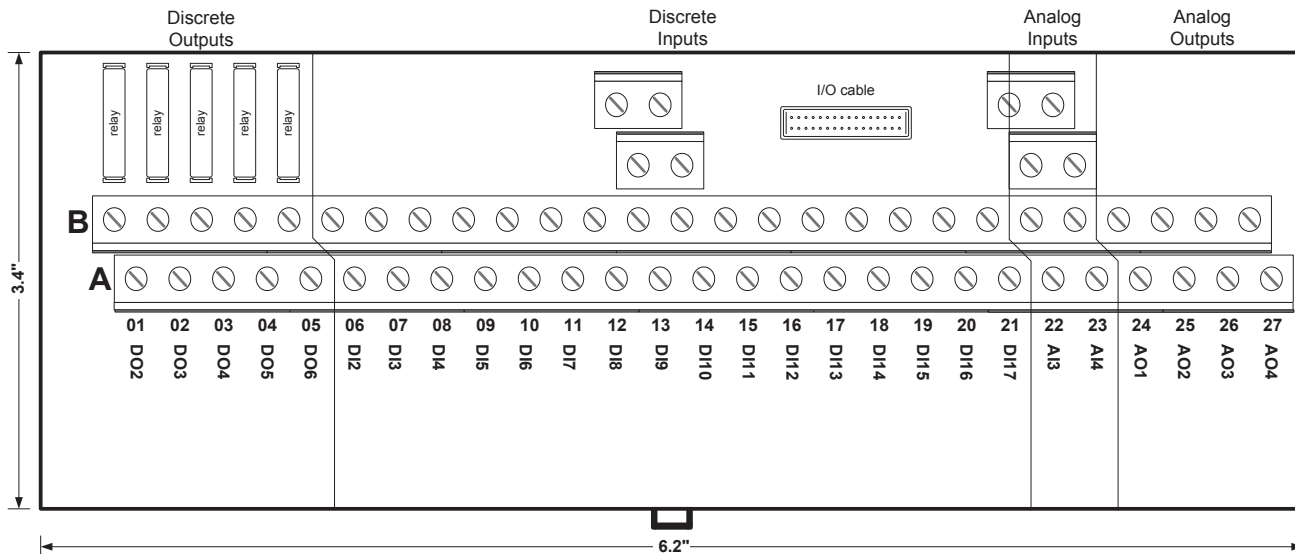

Discrete Outputs Wiring

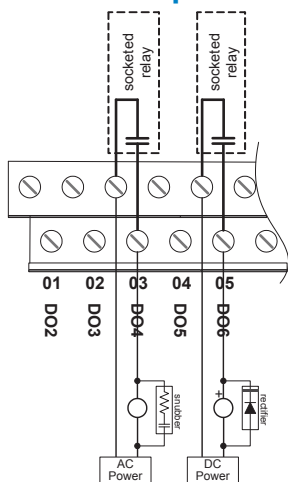

Discrete Inputs Wiring

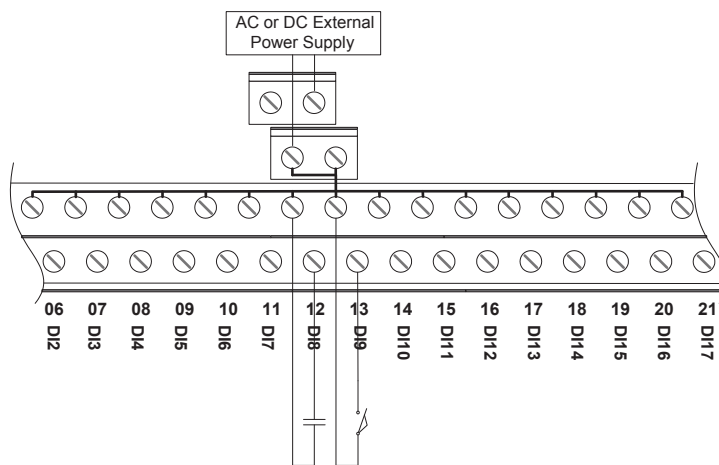

Analog Inputs Wiring Loop Powered Devices

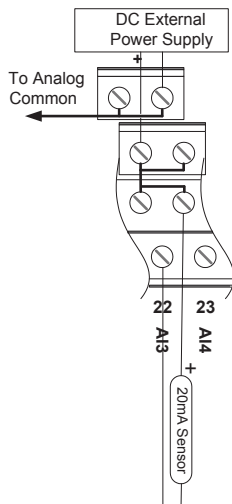

Analog Inputs Wiring Self Powered Devices

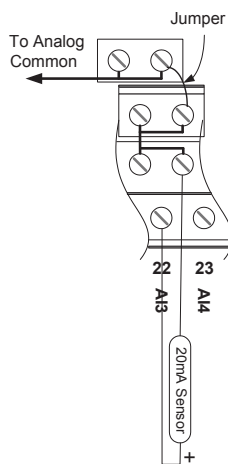

Analog Outputs Wiring

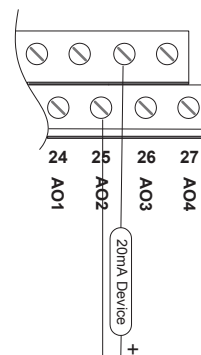

Refer to the installation manual for additional installation details and precautions.